

**glassinox**



glassinox.com



**MAMPARAS DE DUCHA**

**glassinox**

# glassinox

**MAMPARAS  
DE DUCHA  
A MEDIDA**

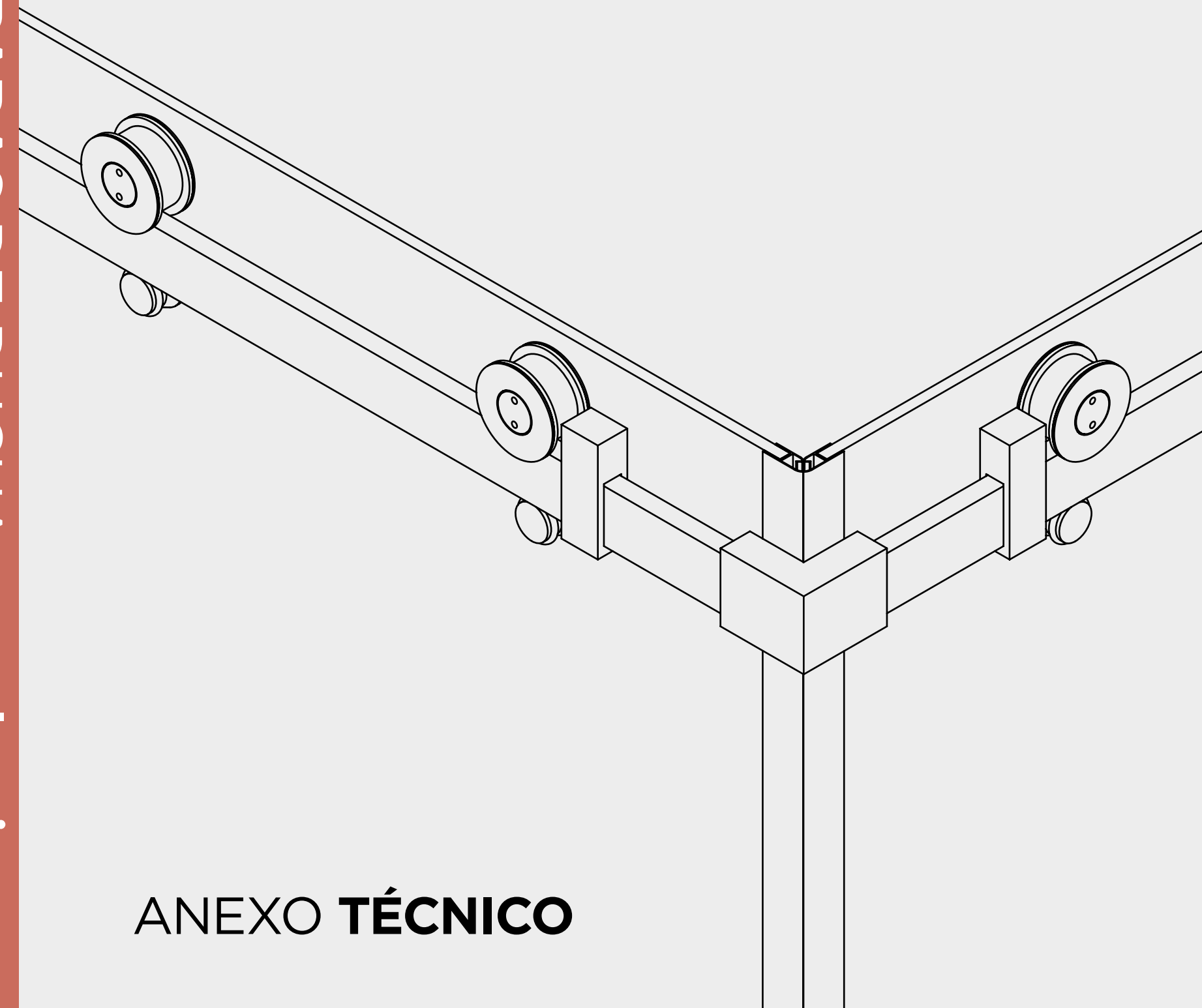

**ANEXO TÉCNICO**

# Serie Vida

## Dossier técnico

02010119

Rodamiento Vida  
Acero inoxidable

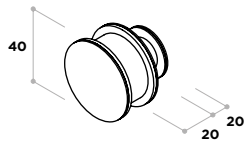

02010111  
02010112

Tope guía Vida  
Acero inoxidable

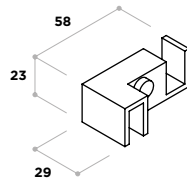

02010113

Tope central guía Vida  
Acero inoxidable

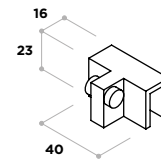

02010116

Tope codo guía Vida  
Acero inoxidable

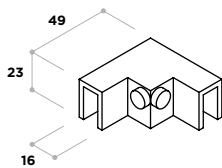

02010252  
02010253

Tope walking  
Acero inoxidable

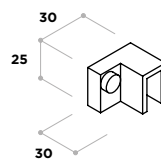

02010115

Terminal embellecedor guía Vida  
Acero inoxidable

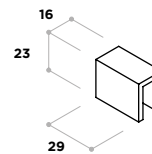

02010117

Pinza vidrio brazo de sujeción Vida  
Acero inoxidable

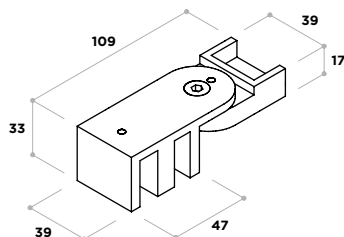

02010066

Pinza vidrio brazo sujeción articulado  
Acero inoxidable

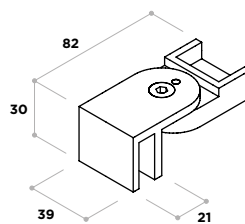

02010118

Cogida pared brazo de sujeción Vida  
Acero inoxidable

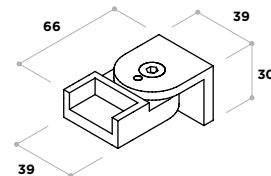

02010067

Cogida "T" brazo sujeción articulado  
Acero inoxidable

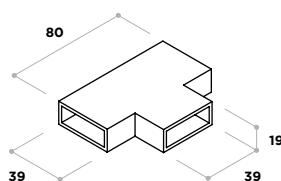

02010114

Calzo fijo Vida  
Acero inoxidable

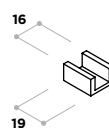

02010134

Tapeta "U"  
Plástico ABS

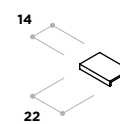

**02010020** Uñero 8 mm  
Acero inoxidable

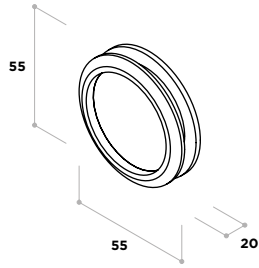

**02030065** Guía Vida 20 x 10 mm  
Acero inoxidable

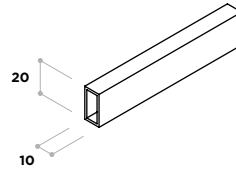

**02030075** Tubo para brazo articulado de acero  
Acero inoxidable

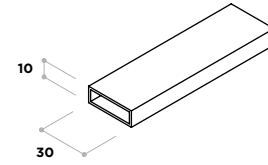

**02030021** "U" de 8 mm  
Acero inoxidable

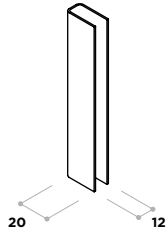

**15000002** Cierre de imán frontal  
con perfil de aluminio a pared

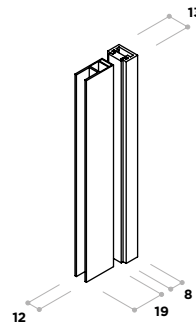

**15000007** Cierre de imán angular adhesivo  
**15000033**

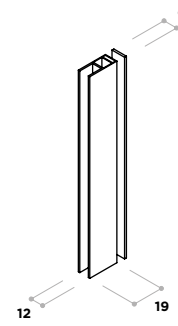

**15000041** Cierre de imán frontal 180°  
**15000042**

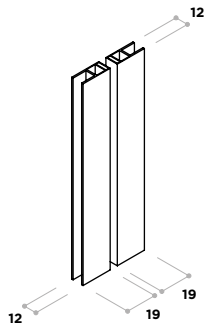

**15000039** Cierre de imán angular 90°  
**15000040**

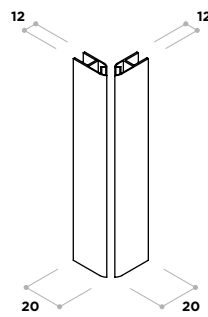

**02020043** Goma de engomar 8 mm



# Serie Óleo

## Dossier técnico

02010075

Rodamiento Óleo  
Acero inoxidable

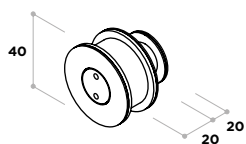

02010081

Codo Óleo  
Acero inoxidable

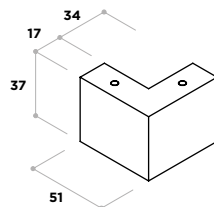

02010078

Cogida pared guía Óleo  
Acero inoxidable

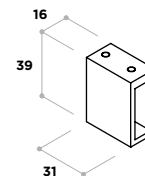

02010082

Cogida guía fijo Garden  
Acero inoxidable

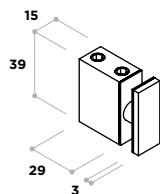

02010077

Cogida guía fijo Óleo  
Acero inoxidable

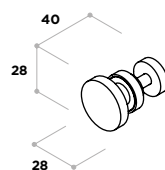

02010076

Antidescarrilamiento Óleo  
Acero inoxidable

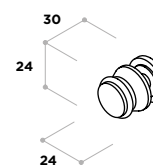

02010080

Pinza inferior Óleo  
Acero inoxidable

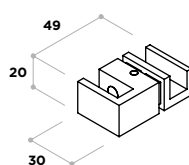

02010079

Tope Óleo  
Acero inoxidable

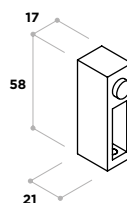

02010377

Codo perfil vierteaguas corredera  
Latón

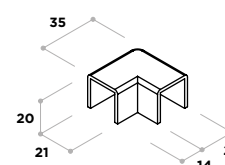

02010378

Embellecedor vierteaguas corredera  
Latón

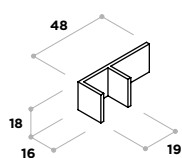

02010134

Tapeta "U"  
Plástico ABS

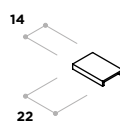

02010020

Uñero 8 mm  
Acero inoxidable

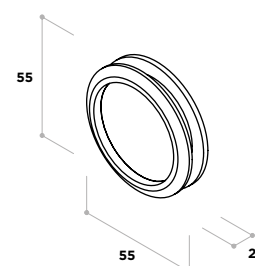

**02030075** Guía Óleo 30 x 10 mm  
Acero inoxidable

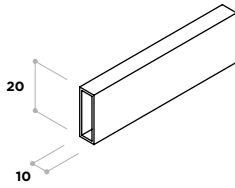

**02030102** Perfil vierteaguas corredera  
Aluminio

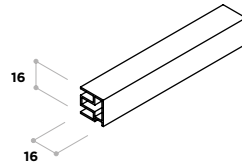

**02030021** "U" de 8 mm  
Acero inoxidable

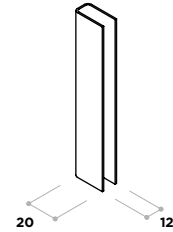

**150000002** Cierre de imán frontal  
con perfil de aluminio a pared  
**150000034**

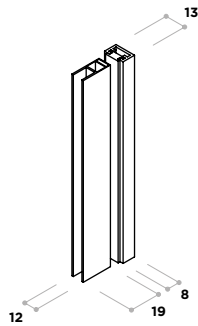

**150000007** Cierre de imán angular adhesivo  
**150000033**

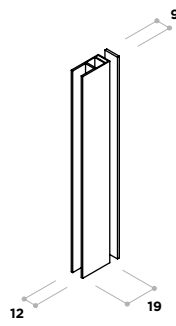

**150000041** Cierre de imán frontal 180°  
**150000042**

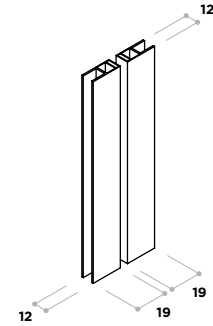

**150000039** Cierre de imán angular 90°  
**150000040**

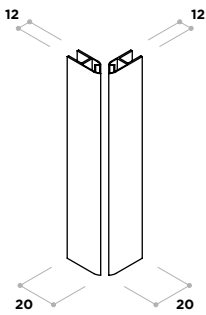

**02020043** Goma de engomar 8 mm

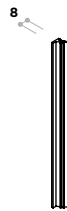

# Serie Mares

## Dossier técnico

02010007

Rodamiento Mares  
Acero inoxidable

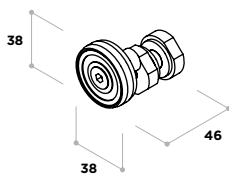

02010008

Codo guía Mares  
Acero inoxidable

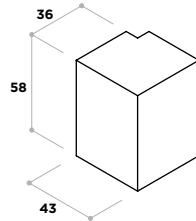

02010009  
02010010

Cogida guía Mares  
Acero inoxidable

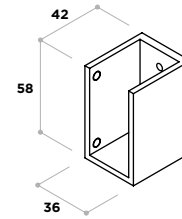

02010022

Pinza inferior Mares  
Latón

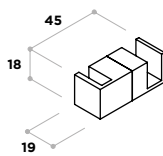

02010006

Pinza guía fijo Mares  
Latón

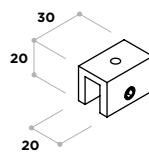

02010001

Tope Mares  
Latón

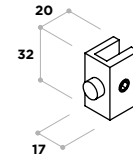

02010377

Codo perfil vierteaguas corredera  
Latón

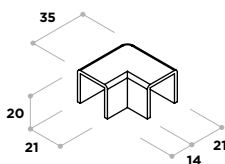

02010378

Embellecedor vierteaguas corredera  
Latón

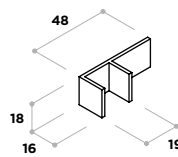

02010382

Tirador cube 20  
Latón

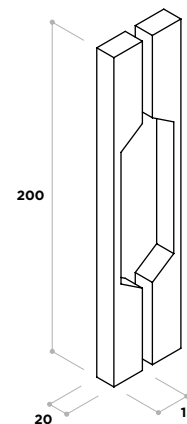

02030004

Guía Mares  
Aluminio

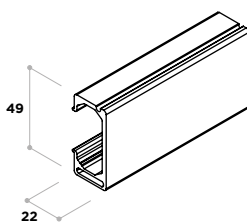

02030005

Forro guía Mares  
Acero inoxidable

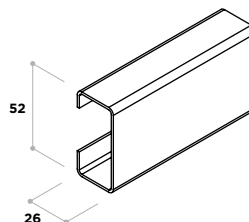

**02030102** Perfil vierteaguas corredera  
Aluminio

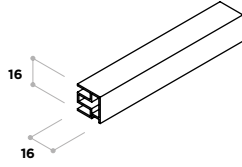

**02030021** "U" de 8 mm  
Acero inoxidable

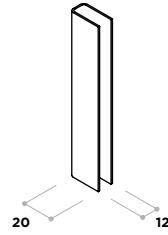

**15000002** Cierre de imán frontal  
con perfil de aluminio a pared  
**150000034**

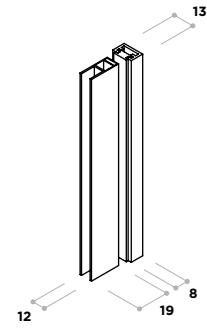

**15000007** Cierre de imán angular adhesivo  
**150000033**

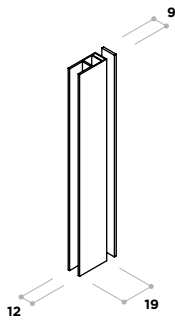

**150000041** Cierre de imán frontal 180°  
**150000042**

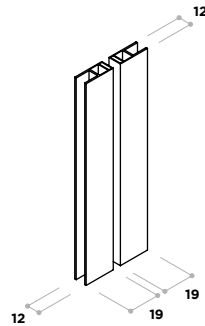

**150000039** Cierre de imán angular 90°  
**150000040**

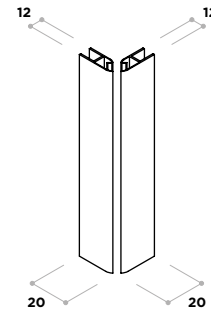

**02020043** Goma de engomar 8 mm



# Serie Arte

## Dossier técnico

02010075

Rodamiento Arte  
Acero inoxidable

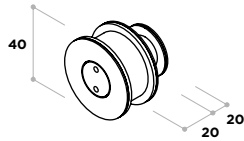

02010081

Codo Arte  
Acero inoxidable

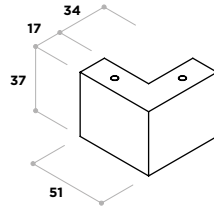

02010078

Cogida pared guía Arte  
Acero inoxidable

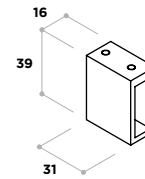

02010082

Cogida guía fijo Garden  
Acero inoxidable

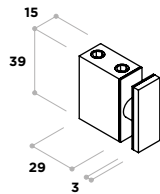

02010077

Cogida guía fijo Arte  
Acero inoxidable

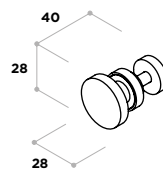

02010076

Antidescarrilamiento Arte  
Acero inoxidable

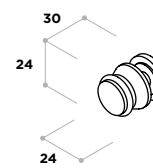

02010022

Pinza inferior Mares  
Latón

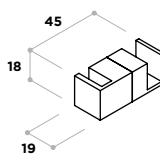

02010079

Tope Arte  
Acero inoxidable

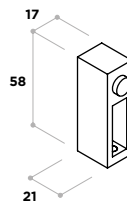

02010377

Codo perfil vierteaguas corredera  
Latón

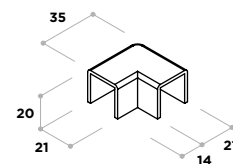

02010378

Embellecedor vierteaguas corredera  
Latón

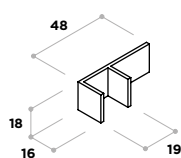

02010134

Tapeta "U"  
Plástico ABS

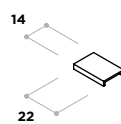

02030075

Guía Arte 30 x 10 mm  
Acero inoxidable

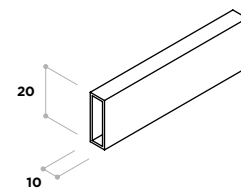



**02030102** Perfil vierteaguas corredera  
Aluminio

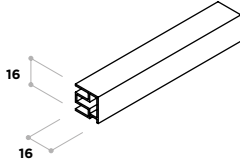

**02030017** "U" de 6 / 8 mm  
Aluminio

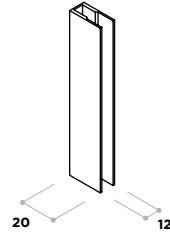

**15000002** Cierre de imán frontal  
con perfil de aluminio a pared  
**150000034**

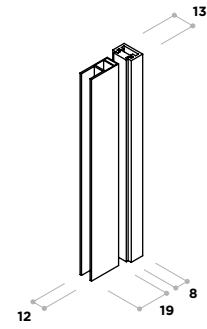

**150000007** Cierre de imán angular adhesivo  
**150000033**

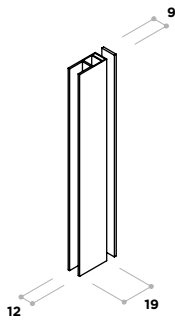

**150000041** Cierre de imán frontal 180°  
**150000042**

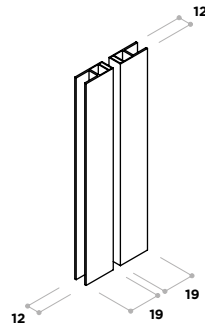

**02010385** Tirador line 50  
Aluminio

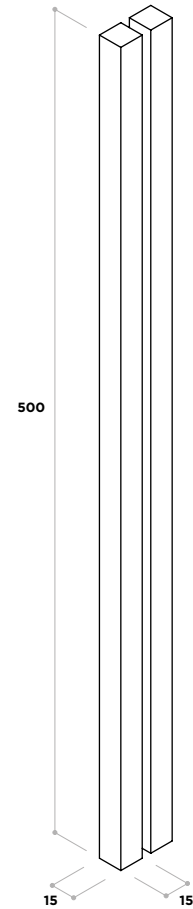

**150000039** Cierre de imán angular 90°  
**150000040**

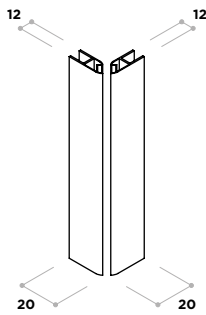

**02020042** Goma de engomar 6 mm

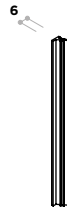

# Serie Océanos

## Dossier técnico

02010007

Rodamiento Mares  
Acero inoxidable

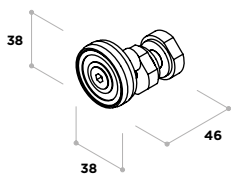

02010008

Codo guía Mares  
Acero inoxidable

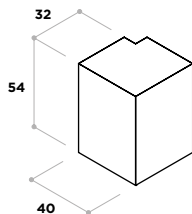

02010009  
02010010

Cogida guía Mares  
Acero inoxidable

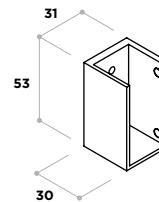

02010022

Pinza inferior Mares  
Latón

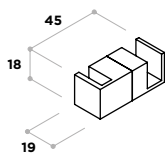

02010006

Pinza guía fijo Mares  
Latón

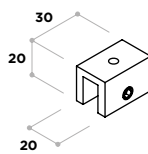

02010001

Tope Mares  
Latón

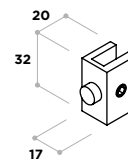

02010377

Codo perfil vierteaguas corredera  
Latón

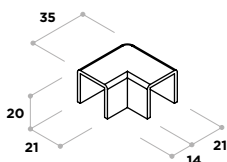

02010378

Embellecedor vierteaguas corredera  
Latón

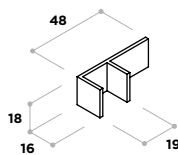

02010382

Tirador cube 20  
Latón

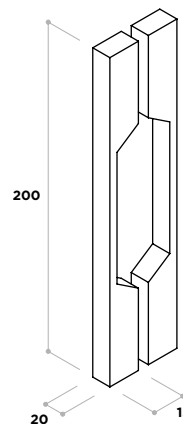

02030004

Guía Mares  
Aluminio

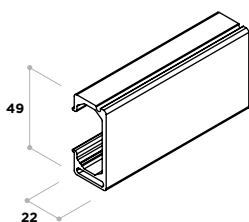

02030102

Perfil vierteaguas corredera  
Aluminio

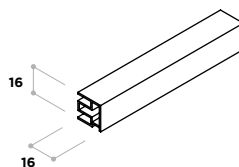

02030017

“U” de 6 / 8 mm  
Aluminio

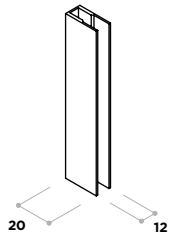

15000002  
15000034

Cierre de imán frontal  
con perfil de aluminio a pared

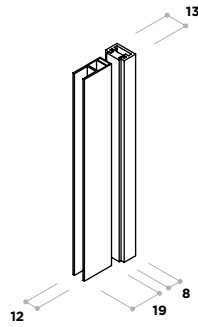

15000007  
15000033

Cierre de imán angular adhesivo

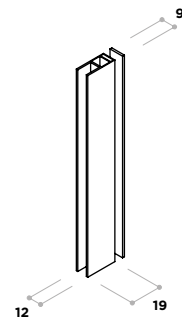

15000041  
15000042

Cierre de imán frontal 180°

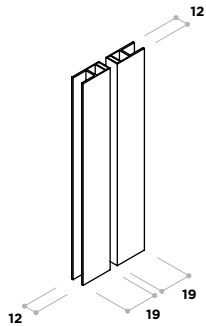

15000039  
15000040

Cierre de imán angular 90°

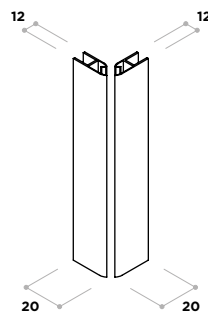

02020042

Goma de engomar 6 mm



# Serie Lagos

## Dossier técnico

02010007

Rodamiento Lagos  
Acero inoxidable

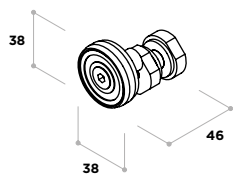

02010023

Codo guía Lagos  
Acero inoxidable

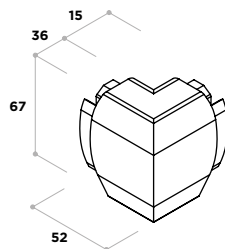

02010002

Cogida guía Lagos  
Acero inoxidable

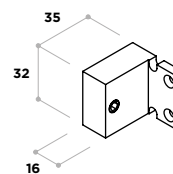

02010024

Embellecedor guía Lagos  
Latón

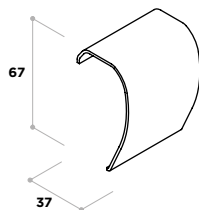

02010021

Pinza inferior Océanos  
Latón

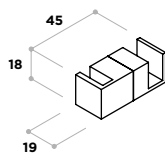

02010001

Tope Lagos  
Latón

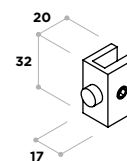

02010377

Codo perfil vierteaguas corredera  
Latón

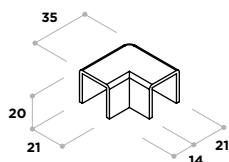

02010378

Embellecedor vierteaguas corredera  
Latón

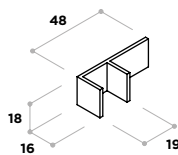

02010382

Tirador cube 20  
Latón

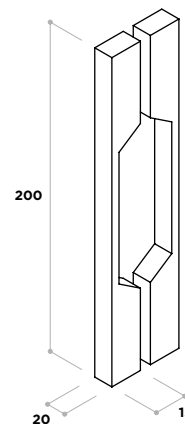

02030001

Guía Lagos  
Aluminio

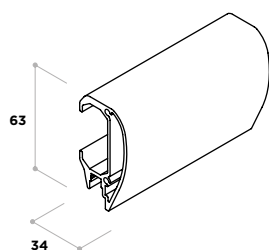

02030102

Perfil vierteaguas corredera  
Aluminio

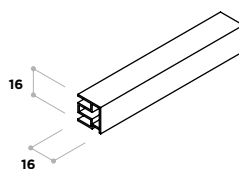

02030017

"U" de 6 / 8 mm  
Aluminio

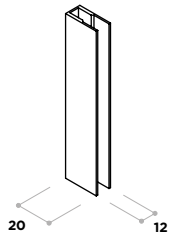

15000002  
15000034

Cierre de imán frontal  
con perfil de aluminio a pared

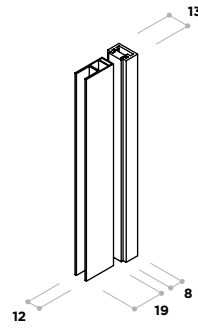

15000007  
15000033

Cierre de imán angular adhesivo

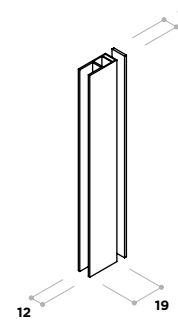

15000041  
15000042

Cierre de imán frontal 180°

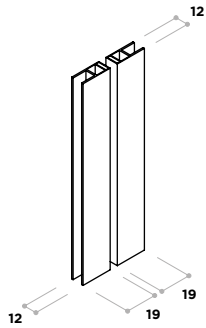

15000039  
15000040

Cierre de imán angular 90°

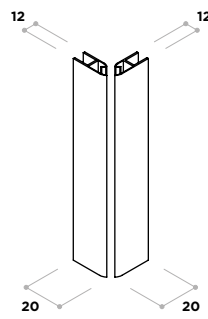

02020042

Goma de engomar 6 mm



# Serie Canales

## Dossier técnico

**02010040** Rodamiento Canales  
Acero inoxidable

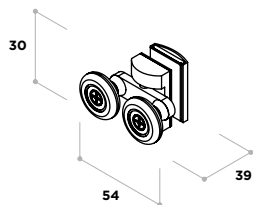

**02010042** Codo guía Canales  
Latón

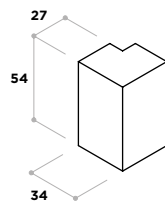

**02010049**  
**02010050** Cogida guía Canales  
Latón

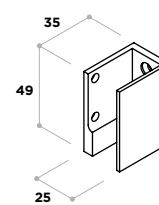

**02010021** Pinza inferior Canales  
Latón

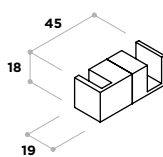

**02010041** Tope Canales  
Latón

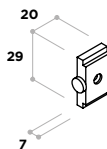

**02010377** Codo perfil vierteaguas corredera  
Latón

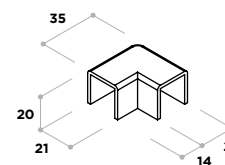

**02010378** Embellecedor vierteaguas corredera  
Latón

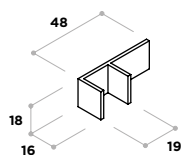

**02030010** Guía Canales  
Aluminio

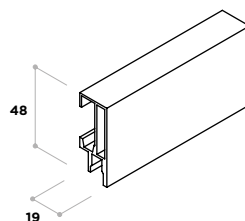

**02010384** Tirador line 25  
Aluminio

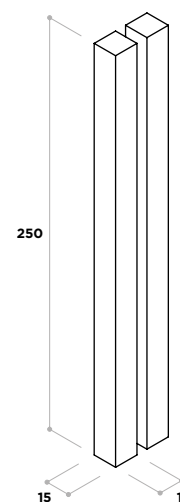

**02030102** Perfil vierteaguas corredera  
Aluminio

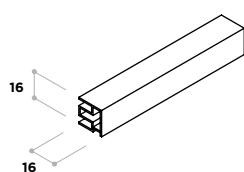

**02030017** "U" de 6 / 8 mm  
Aluminio

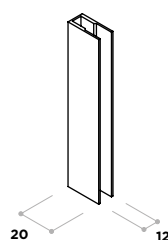

**15000002** Cierre de imán frontal  
**15000034** con perfil de aluminio a pared

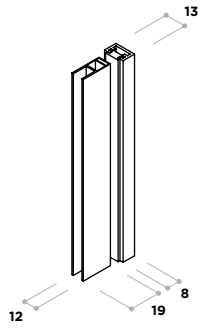

**15000007** Cierre de imán angular adhesivo  
**15000033**

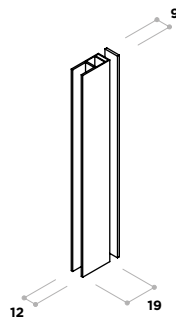

**15000041** Cierre de imán frontal 180°  
**15000042**

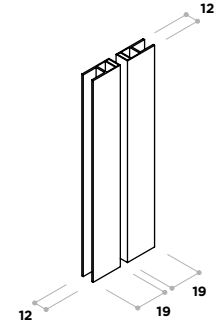

**15000039** Cierre de imán angular 90°  
**15000040**

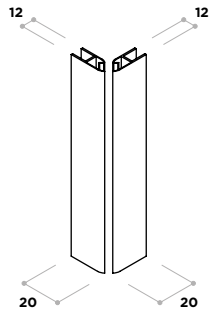

**02020042** Goma de engomar 6 mm

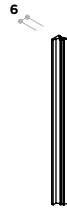

# Serie Islas

## Dossier técnico

**02010062**

Bisagra pared 90°  
Acero inoxidable

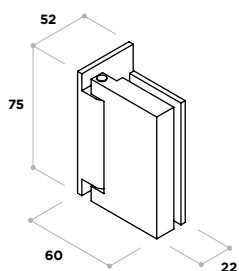

**02010063**

Bisagra doble 90°  
Acero inoxidable

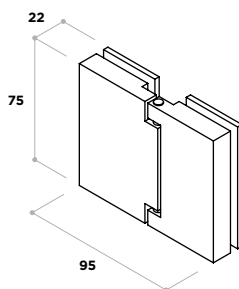

**02010056**

Bisagra pared 180°  
Acero inoxidable

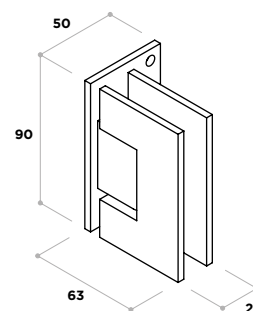

**02010057**

Bisagra doble 180°  
Acero inoxidable

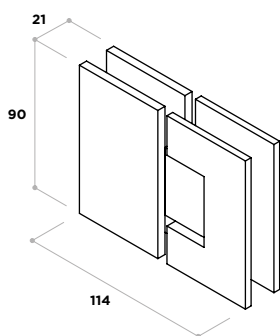

**02010061**

Bisagra doble 180° vértice  
Acero inoxidable

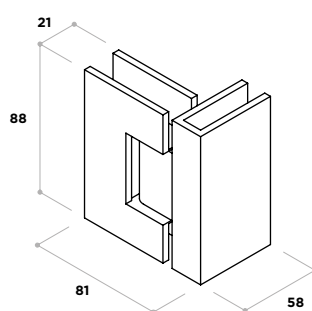

**02010066**

Pinza vidrio brazo sujeción  
Acero inoxidable

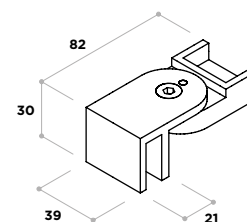

**02010065**

Cogida pared brazo sujeción  
Acero inoxidable

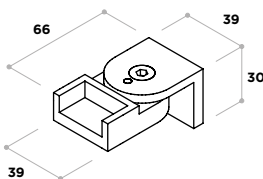

**02010067**

Cogida "T" brazo sujeción articulado  
Acero inoxidable

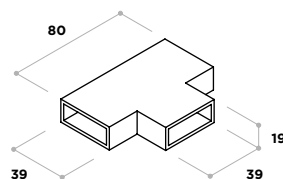

**02010127**

Terminal perfil bajo a pared  
Plástico ABS

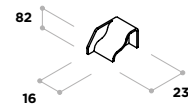

**02010122**  
**02010123**

Terminal perfil bajo fijo frontal  
Plástico ABS

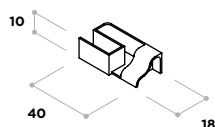

**02010124**

Codo perfil bajo abatibles  
Plástico ABS

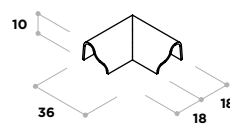

**02010125**  
**02010126**

Terminal perfil bajo fijo lateral  
Plástico ABS

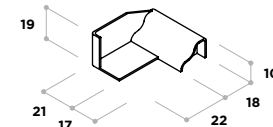



**02010133** Tapeta marco-expansor Islas  
Acero inoxidable

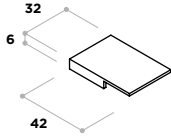

**02010134** Tapeta "U"  
Plástico ABS

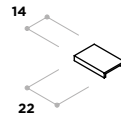

**02030037** Expansor Islas  
Aluminio

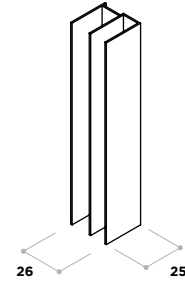

**02030075** Marco Islas  
Aluminio

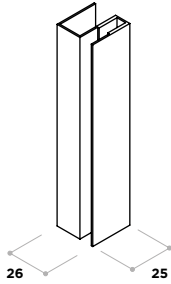

**02030074** Tubo para brazo articulado  
**02030075** Aluminio / Acero inoxidable

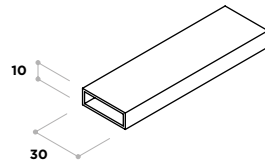

**02030021** "U" de 8 mm  
Acero inoxidable

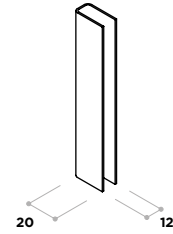

**02030039** Perfil bajo abatibles  
Aluminio

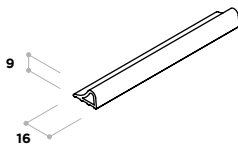

**150000004** Cierre imán frontal a pared 90°  
**150000012** Aluminio

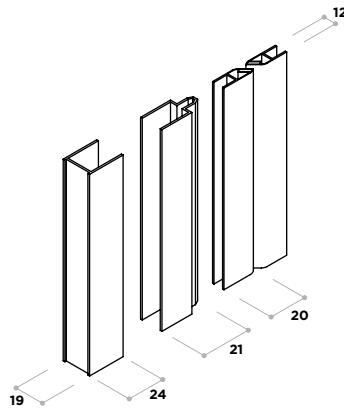

**02010383** Tirador cube 25

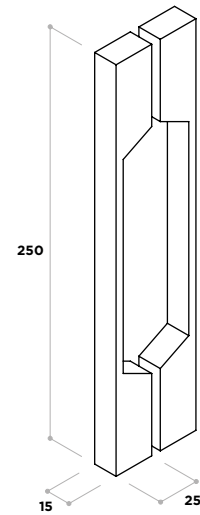

**150000039** Cierre de imán angular 90°  
**150000040**

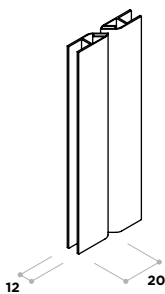

**150000039** Cierre de imán angular 90°  
**150000040**

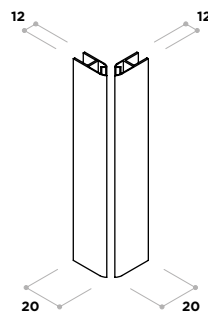

# Serie Sonia

## Dossier técnico

02010381  
02010392

Kit abatible Sonia  
Zamak

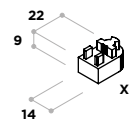
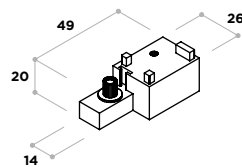
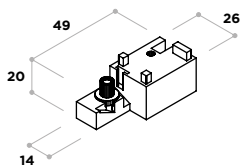

02010066 Pinza vidrio brazo sujeción  
Acero inoxidable

02010065 Cogida pared brazo sujeción  
Acero inoxidable

02010067 Cogida "T" brazo sujeción articulado  
Acero inoxidable

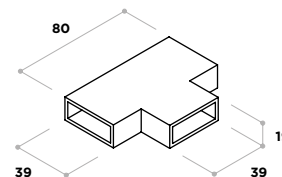
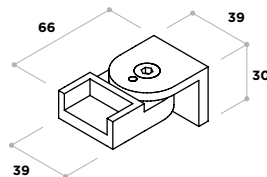
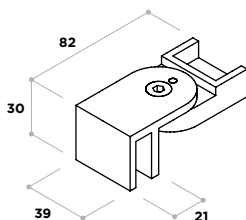

02010127 Terminal perfil bajo a pared  
Plástico ABS

02010122 Terminal perfil bajo fijo frontal  
Plástico ABS

02010124 Codo perfil bajo abatibles  
Plástico ABS

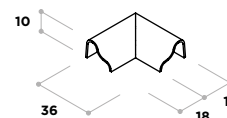
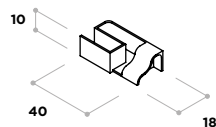
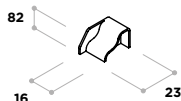

02010125 Terminal perfil bajo fijo lateral  
Plástico ABS

02010390 Terminal perfil bajo a expansor  
Plástico ABS

02010379 Tapón cuadradillo Sonia  
Latón

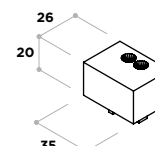
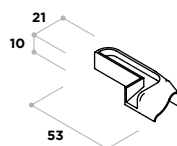
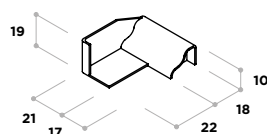

**02010380** Tapeta expansor Sonia  
Latón

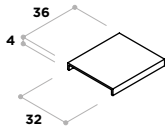

**02030213** Expansor Sonia  
Aluminio

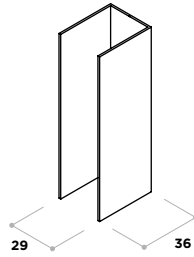

**02030214** Cuadradillo Sonia  
Aluminio

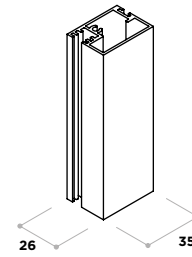

**02030215** Redondillo Sonia  
Aluminio

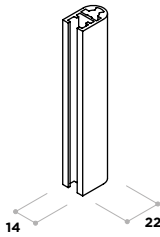

**02030074** Tubo para brazo articulado  
**02030075** Aluminio / Acero inoxidable

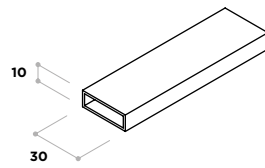

**02030039** Perfil bajo abatibles  
Aluminio

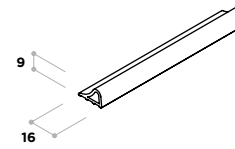

**02010387** Maneta cube  
Latón

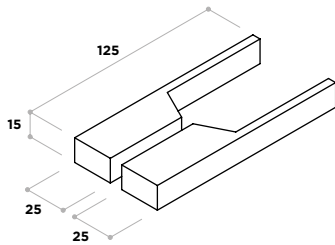

**150000037** Cierre imán frontal a pared Sonia  
**150000038**

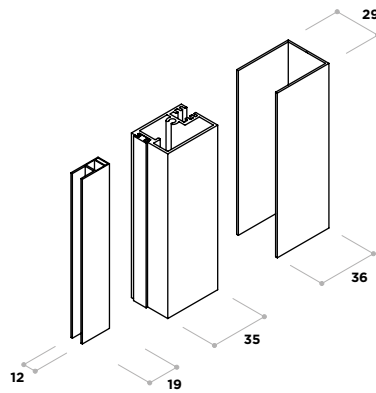

**150000041** Cierre de imán frontal 180°  
**150000042**

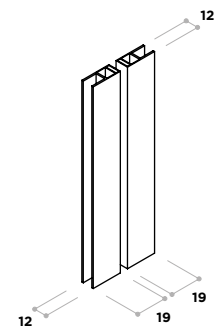

**150000039** Cierre de imán angular 90°  
**150000040**

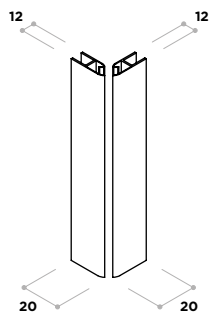

# Serie Paraíso

## Dossier técnico

**02010058** Bisagra acero inox. plegable Paraíso  
Acero inoxidable

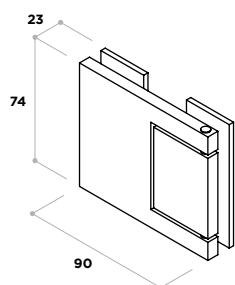

**02010056** Bisagra pared 180°  
Acero inoxidable

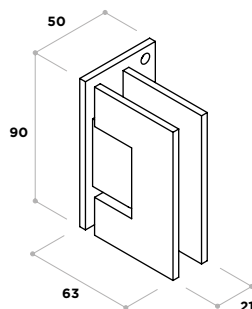

**02010057** Bisagra doble 180°  
Acero inoxidable

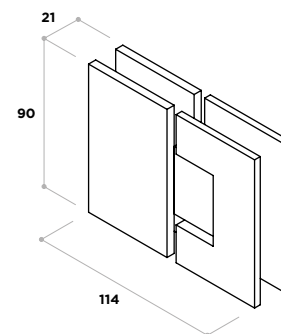

**02010061** Bisagra doble 180° vértice  
Acero inoxidable

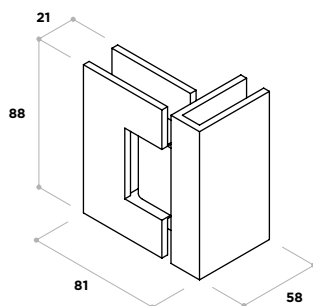

**02010066** Pinza vidrio brazo sujeción  
Acero inoxidable

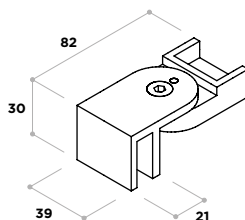

**02010065** Cogida pared brazo sujeción  
Acero inoxidable

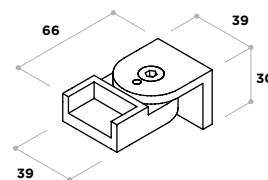

**02010067** Cogida "T" brazo sujeción articulado  
Acero inoxidable

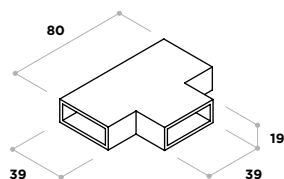

**02010127** Terminal perfil bajo a pared  
Plástico ABS

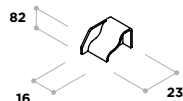

**02010122** Terminal perfil bajo fijo frontal  
Plástico ABS

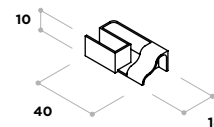

**02010124** Codo perfil bajo abatibles  
Plástico ABS

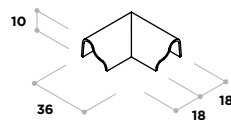

**02010125** Terminal perfil bajo fijo lateral  
Plástico ABS

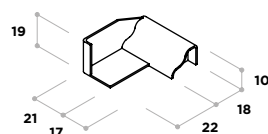

**02010133** Tapeta marco-expansor Islas  
Acero inoxidable

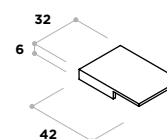

02030037

Expansor Islas  
Aluminio

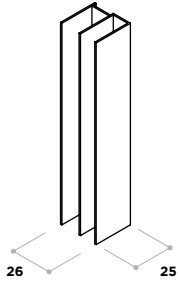

02030075

Marco Islas  
Aluminio

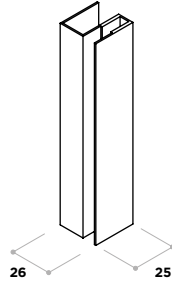

02030074  
02030075

Tubo para brazo articulado  
Aluminio / Acero inoxidable

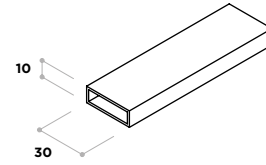

02030039

Perfil bajo abatibles  
Aluminio

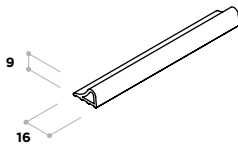

02010386

Pomo cube

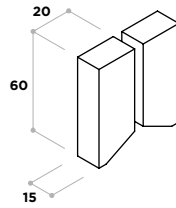

150000004  
150000012

Cierre imán frontal a pared 90°  
Aluminio

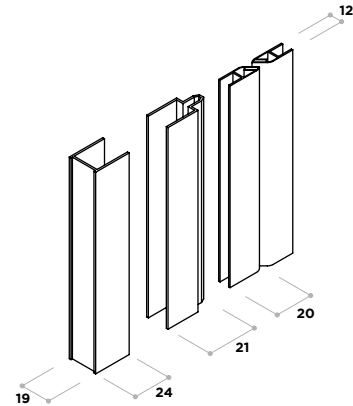

150000039  
150000040

Cierre de imán angular 90°

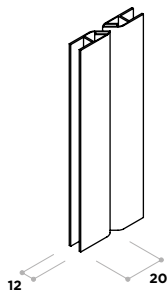

150000039  
150000040

Cierre de imán angular 90°

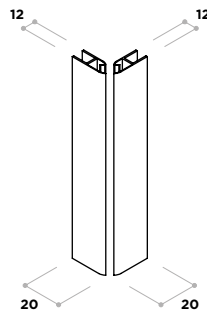

# Serie Sevilla

## Dossier técnico

02010381  
02010392

Kit abatible Sonia  
Zamak

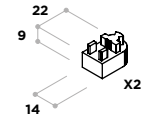
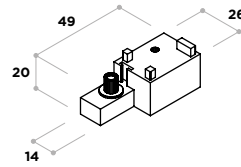
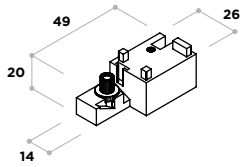

02010059

Bisagra plegable Sevilla  
Latón

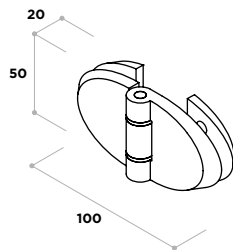

02010066

Pinza vidrio brazo sujeción  
Acero inoxidable

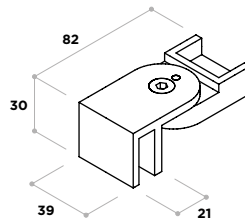

02010065

Cogida pared brazo sujeción  
Acero inoxidable

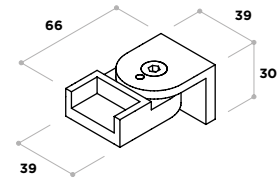

02010067

Cogida "T" brazo sujeción articulado  
Acero inoxidable

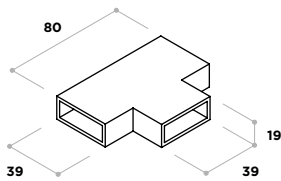

02010122  
02010123

Terminal perfil bajo fijo frontal  
Plástico ABS

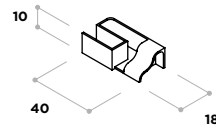

02010124

Codo perfil bajo abatibles  
Plástico ABS

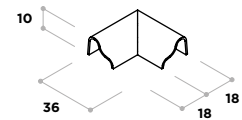

02010125  
02010126

Terminal perfil bajo fijo lateral  
Plástico ABS

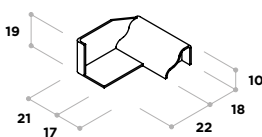

02010390  
02010391

Terminal perfil bajo a expansor  
Plástico ABS

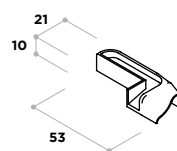

02010379

Tapón cuadradillo Sonia  
Latón

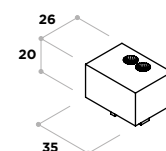

**02010380** Tapeta expansor Sonia  
Latón

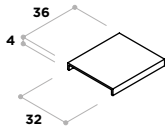

**02030213** Expansor Sonia  
Aluminio

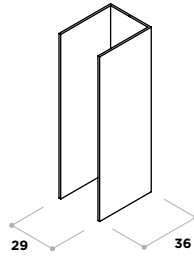

**02030214** Cuadradillo Sonia  
Aluminio

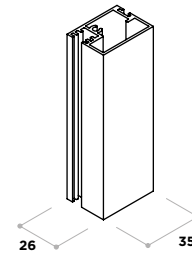

**02030215** Redondillo Sonia  
Aluminio

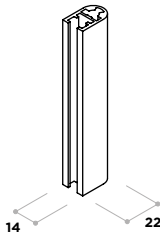

**02030074** Tubo para brazo articulado  
**02030075** Aluminio / Acero inoxidable

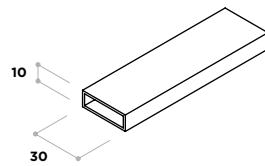

**02030039** Perfil bajo abatibles  
Aluminio

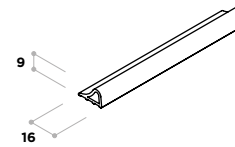

**02010386** Pomo cube

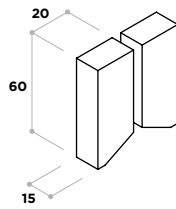

**150000037** Cierre imán frontal a pared Sonia  
**150000038**

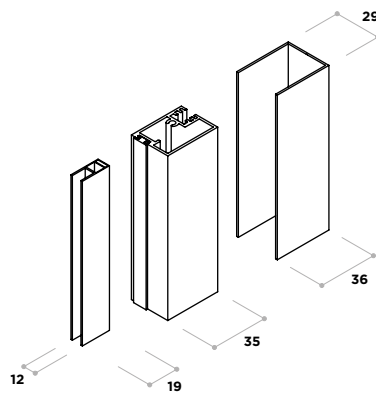

**150000041** Cierre de imán frontal 180°  
**150000042**

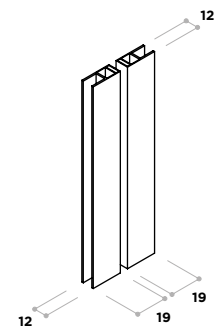

**150000039** Cierre de imán angular 90°  
**150000040**

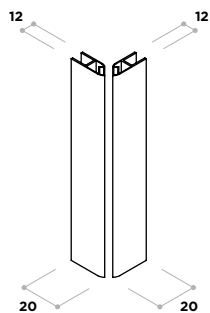

# Serie Oriental

## Dossier técnico

**02010057**

Bisagra doble 180°  
Acero inoxidable

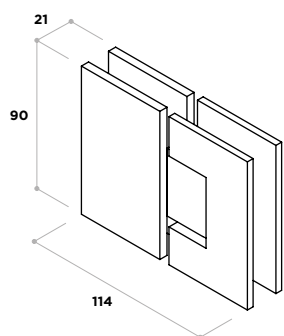

**02010066**

Pinza vidrio brazo sujeción  
Acero inoxidable

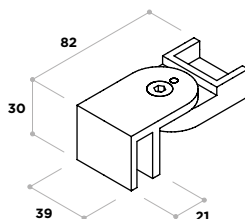

**02010065**

Cogida pared brazo sujeción  
Acero inoxidable

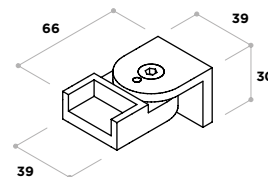

**02010067**

Cogida "T" brazo sujeción articulado  
Acero inoxidable

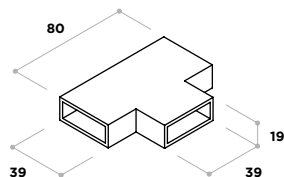

**02010127**

Terminal perfil bajo a pared  
Plástico ABS

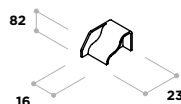

**02010128**

**02010390**

Terminal perfil bajo a expansor  
Plástico ABS

**02010391**

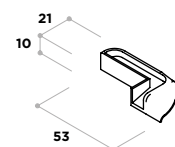

**02010134**

Tapeta "U"  
Plástico ABS

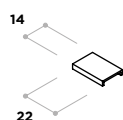

**02010182**

Tapeta expansor perfilada  
Acero inoxidable

**02010183**

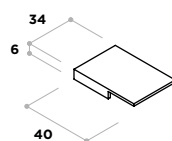

**02010380**

Tapeta expansor Sonia  
Latón

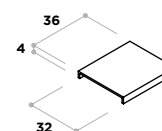

**02030178**  
**02030212**

Marco perfilada  
Aluminio

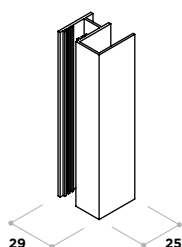

**02030222**  
**02030223**

Expansor perfilada  
Aluminio

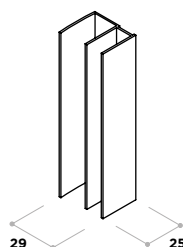

**02030218**  
**02030219**

Perfil V perfilada  
Aluminio

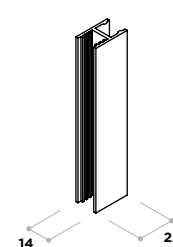



**02030074** Perfil tapeta perfilada  
**02030075** Aluminio

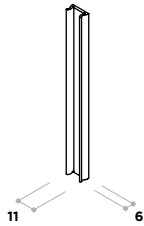

**02010216** Perfil H perfilada  
**02010217** Aluminio

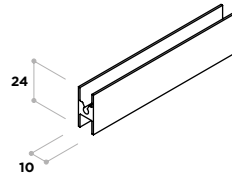

**02010381** Kit abatible Sonia  
**02010392** Zamak

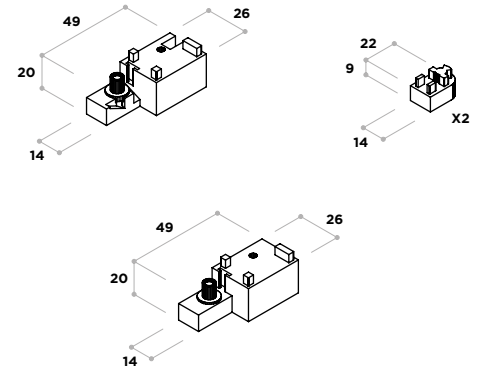

**02010379** Tapón cuadradillo Sonia  
Latón

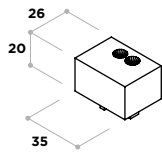

**02030213** Expansor Sonia  
Aluminio

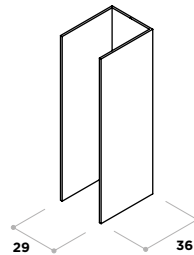

**02030214** Cuadradillo Sonia  
Aluminio

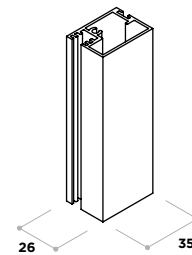

**02030215** Redondillo Sonia  
Aluminio

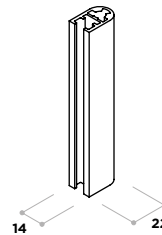

**02030021** "U" de 8 mm  
Acero inoxidable

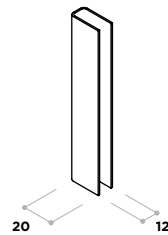

**02030017** "U" de 6 / 8 mm  
Aluminio

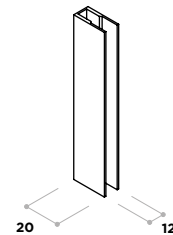

**02030039** Perfil bajo abatibles  
Aluminio

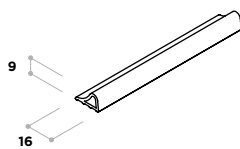

**02030074** Tubo para brazo articulado  
**02030075** Aluminio / Acero inoxidable

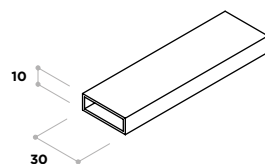

# Serie Playas

## Dossier técnico

02010056

Bisagra pared 180°  
Acero inoxidable

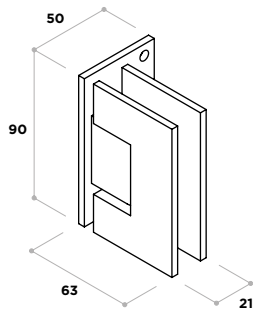

02010051

Rodamiento Bolonia-Tarifa  
Acero inoxidable

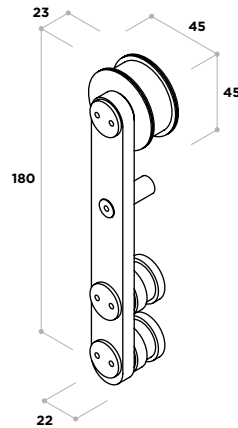

02010007

Rodamiento Meca-Zahara  
Acero inoxidable

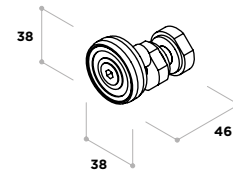

02010054

Cogida pared guía Bolonia-Tarifa  
Acero inoxidable

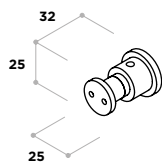

02010053

Terminal guía Bolonia-Tarifa  
Acero inoxidable

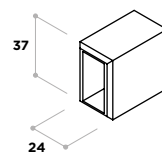

02010052

Tope Bolonia-Tarifa  
Acero inoxidable

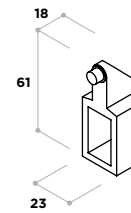

02010055

Pinza inferior Playas  
Acero inoxidable

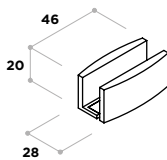

02010001

Tope Meca-Zahara  
Latón

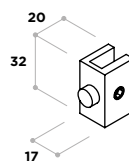

02030155

Forro acero inox. guía Meca-Zahara  
Acero inoxidable

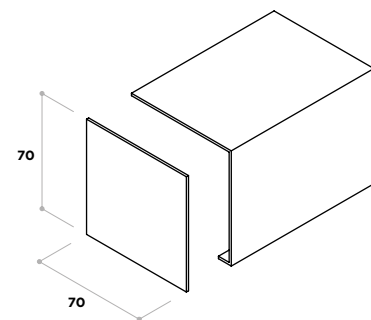

02030016

Guía Bolonia-Tarifa  
Acero inoxidable

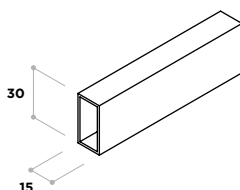

02030004

Guía Meca-Zahara  
Aluminio

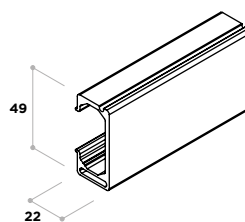

02010020

Uñero 8 mm  
Acero inoxidable

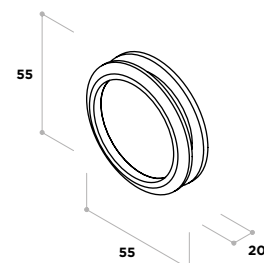

02010383

Tirador cube 25

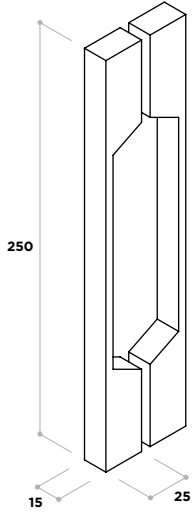

# Accesorios extra

## Dosier técnico

02010071

Codo brazo perimetral  
Acero inoxidable

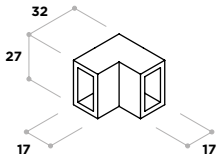

02010069

Pinza vidrio brazo perimetral  
Acero inoxidable

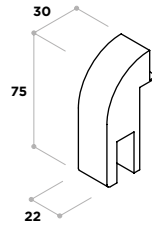

02010070

Cogida "T" brazo perimetral  
Acero inoxidable

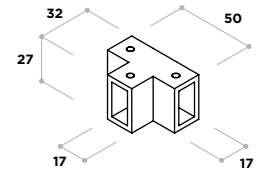

02010068

Cogida pared brazo perimetral  
Acero inoxidable

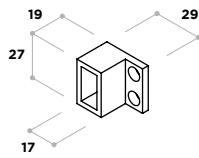

02030086

Tubo para brazo perimetral  
Acero inoxidable

